

Unit: mm

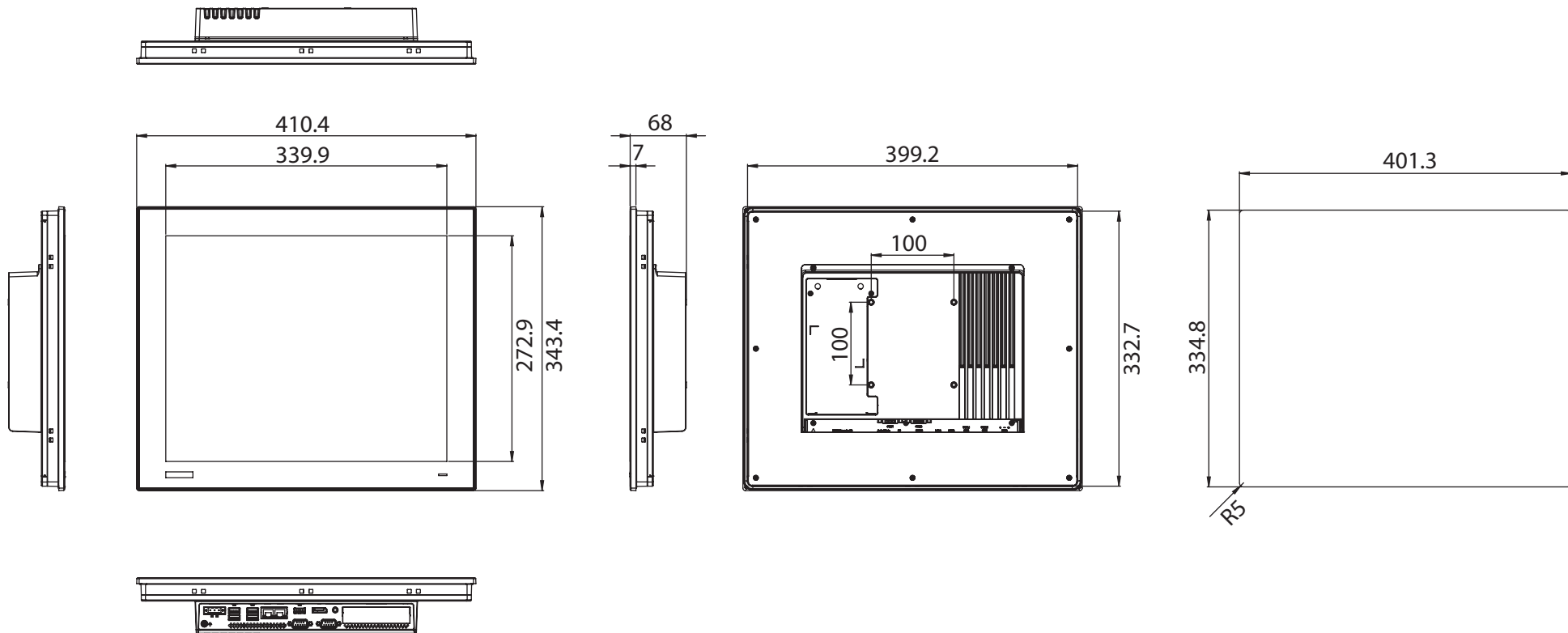

TPC-317 Panel Cutout Dimensions: 401.3 x 334.8 mm (15.80 x 13.18 in)